

TONONE

technical specifications



BOLT desk 1 arm clamp

Design by Anton de Groof, 2013

Starting point for the products of Tonone is the passion for traditional mechanics. The first product line that resulted from this fascination is the lamp series 'Bolt'. Key element in this industrial series is the joint construction that can be adjusted with a wingnut-shaped tool. Besides being a functional tool, this wingnut is integrated in the design of the lamp itself as a distinctive visual element. The Bolt collection is available in 29 different models and in 10 colors.

Type	Desk lamp
Environment	Indoor
Material	Steel & aluminum
Wingnut	Wingnut Solid Brass included
Cord length	2400 mm
Weight	1,9 kg
Voltage	220-240 V
Max Watt	60 Watt
Socket	E27
IP	20
Lightsource	Lightsource not included

Packaging	
Weight	3,9 kg
Length	75 cm
Width	47 cm
Height	18 cm

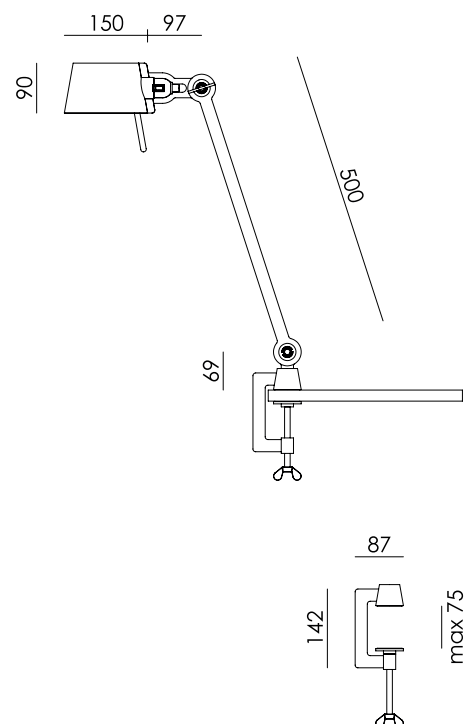

TONONE

technical specifications



	Article number
	smokey black 1025
	flux green 1027
	pure white 1029
	midnight grey 1255
	ash grey 1032
	striking orange 1030
	lightning white 1028
	thunder blue 1031
	daybreak rose 1461
	sunny yellow 1419